



Scramble 'N Slide Play Center

ASSEMBLY INSTRUCTIONS

No. 2016
Age: 2 - 6

DO NOT DISCARD: IMPORTANT LITERATURE. PLEASE READ AND FOLLOW INSTRUCTIONS CAREFULLY AND IDENTIFY ALL PARTS BEFORE ASSEMBLY.

TO AVOID SERIOUS INJURY:

DO NOT install this product on a hard surface. Fall onto hard surfaces could result in head or other serious injuries. Never put on concrete, asphalt, wood, packed earth or other hard surfaces. Carpet over hard floors may not prevent injury.

SAFETY INSTRUCTIONS

IMPORTANT:

- This product is designed for family domestic use only. Suitable for indoor and outdoor use. Adult assembly required. Phillips / cross-head screwdriver (not included) required during assembly.

WARNING: CHOKING HAZARD - Small parts. This product contains small parts and sharp points which are necessary for assembly. Prior to or during assembly of this product, keep all components out of children's reach. Small parts pose a choke hazard to children under 3 years of age.

- Place this product on level ground at least 2 meters away from a fence, building, overhead branches, laundry line or electrical wires.

- Instruct children on proper use of this product, only after properly installed and assembled, and not in any manner other than intended. Adult supervision required at all time. DO NOT leave child unattended.

- DO NOT allow children to wear loose-fitting clothing including ponchos, scarves and garments with drawstrings. Well fitting shoes must be worn all times.

- Slide feet first. One child at a time.

- Teach and instruct children to sit in the center of the swings with their full weight on the seats. Do not allow children to stand on the swing seats.

- Always keep safety strap secure during use.

- Instruct children to hold on to swing with both hands.

- Warn children not to get off the equipment while in motion.

- DO NOT swing empty seats. These may hit other children or yourself.

- DO NOT allow children to stand, walk close to, behind, in front of, or between moving plays. Instruct children to keep a safe distance away from moving plays to avoid being hit by items in play.

- Although basketball net is factory pre-assembled, the knots may loosen during transportation. To ensure safety, check and re-tie the net before use. The net can present a strangulation hazard to children under 3 years of age.

- DO NOT allow children to climb on the product when the product is wet. Slippery can result in slips or potential fall.

- When temperature falls below -18°C/0°F, outdoor use of this product is not recommended. In extreme cold, plastic materials lose resilience and may become brittle and crack upon impact. Remove and store product indoors.

- Maximum weight: 50 Lbs (23 kg) on each individual play. Limit 3 children.

PARTS LIST		
#	DESCRIPTION	QTY
A	Side Panel	3
B	Slide Chute	1
C	Platform	1
D	Step	2
E	Swing Seat Back	1
F	Swing Seat	1
G	Swing Arm	2
H	Metal Tube	1
I	Castle Top	1
J	Back Plate	1
K	Wide Base	1
L	Screw Cap	4
M	Metal Screw	8
N	Basketball Rim	1
O	Large Metal Screw	2

ASSEMBLY INSTRUCTIONS

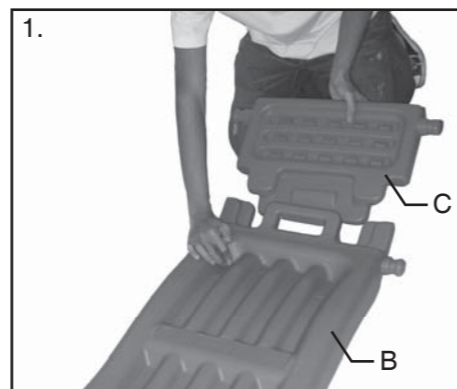

Connect the Platform (C) to the Slide Chute (B). Lift the platform slightly, sliding towards to the chute and snap together.

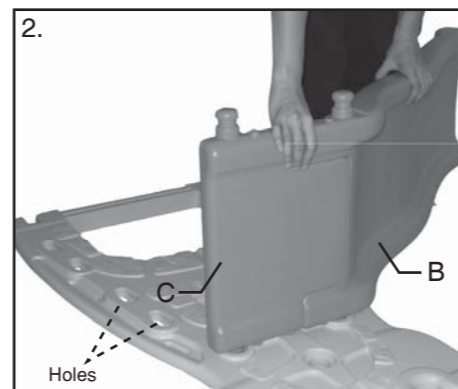

Lay one of the Side Panel (A) (WITHOUT THE SOCCER NET) on a flat surface. Make sure the Side Panel holes are at the opposite side of the slide assembly. Insert the tabs into the slots of the wall. DO NOT lock them yet.

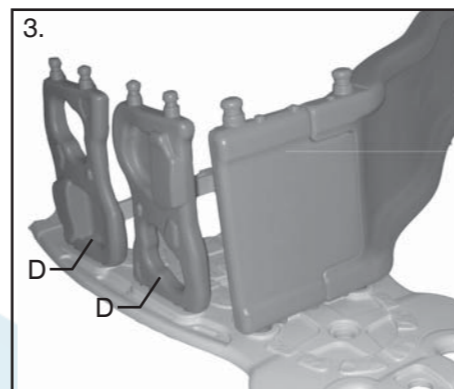

Place the pegs of the Step (D) to the slots of the Side Panel. Ensure the embossed design is facing out. DO NOT lock any parts at the moment.

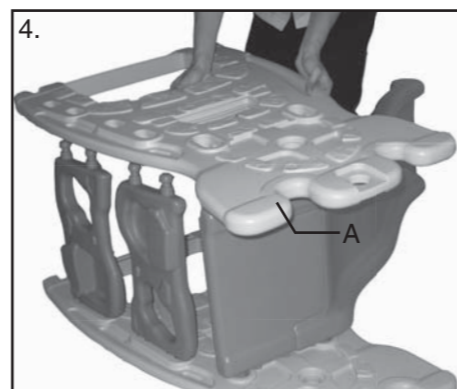

Place the other Side Panel (A) (WITHOUT THE SOCCER NET) onto the aligned piece. Now, carefully turn up the entire assembly, press each peg downwards firmly into its respective slot until all pegs are snap into place. IMPORTANT: Make sure the slide (B & C) and both steps (D) are interlocked properly with the side walls.

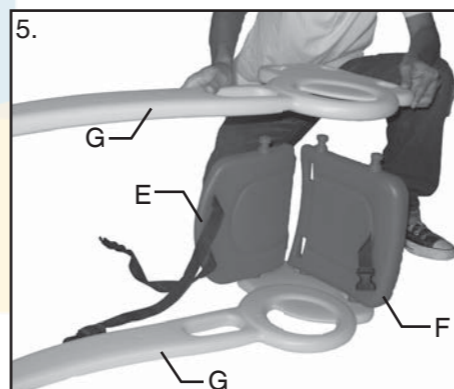
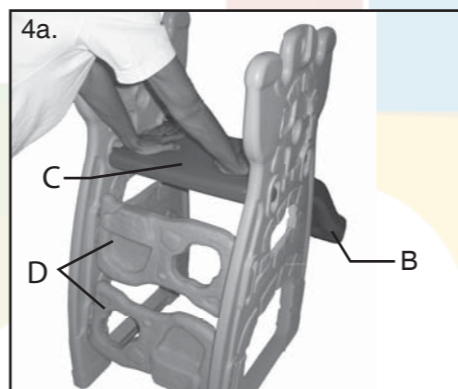

Lay the Swing Arm (G) on the ground, join the Swing Back (E) and the Seat (F) to the Swing Arm by matching pegs and holes. Then, place the other Swing Arm (G) above the swing assembly.

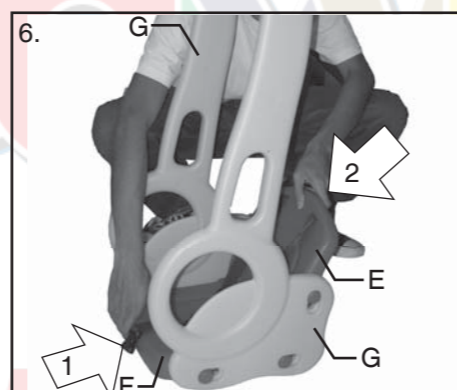

Assemble the seat (F) first, then the seat back (E). Slide and snap the seat panel into the slots. Make sure the pegs are locked into place. Finally, press the seat back firmly downwards to fix its position to the swing arms and the swing seat. Check all pegs are locked securely.

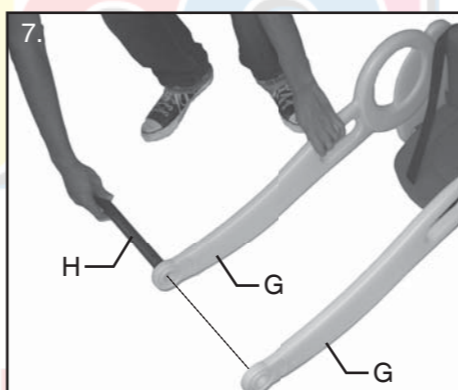

Insert the Metal Tube (H) through holes on the top of each swing arm.

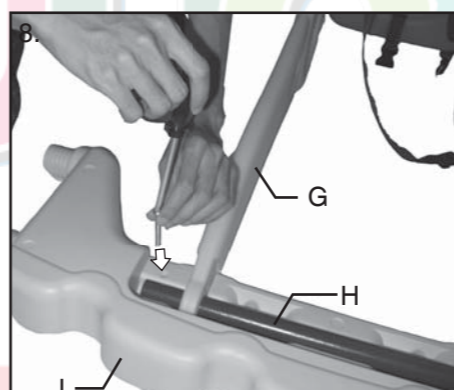

Place the swing assembly into the inner side of the castle top (I). Lock the metal tube ends with two (x2) M6 Large Metal Screws (O).

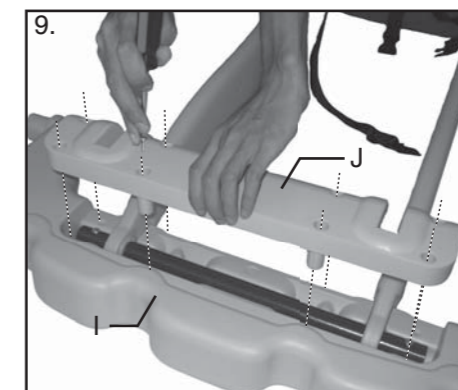

Cover the castle top with its Back Plate (J), then fasten all eight (x8) metal screws (M) to tighten in place.

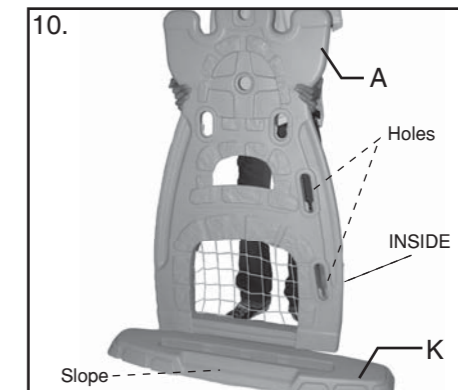

Attach the last Side Panel (A) (with Soccer net facing **INSIDE**) to the Wide Base (K) as shown.

IT IS RECOMMENDED TO HAVE ANOTHER ADULT TO COMPLETE THE FOLLOWING STEPS.

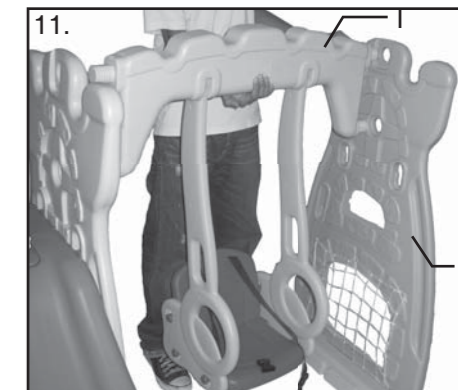

Attach both sides of the top assembly to the side panels. Insert the tab ends into the slots of walls (A).

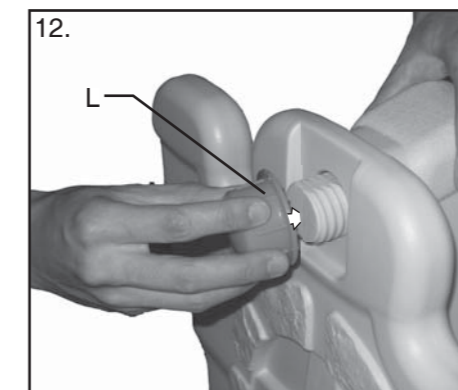

Hand thread the Plastic Screw Cap (L) to lock each tab end, DO NOT LOCK THE UPPER RIGHT TAB of the soccer net panel at the moment.

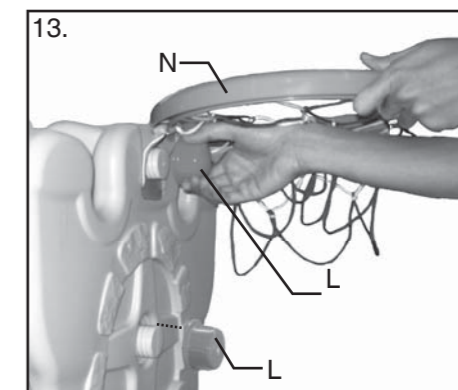

Now, place the Basketball Rim (N) to the extended tab at the upper RIGHT SIDE PANEL. Fasten a Screw Cap to fix its position. Make sure all four (x4) screw caps are fastened securely during steps 11 & 12.



Picture shows the final assembled product.

CARE AND MAINTENANCE

- Verify that all the pegs are securely tapped together before use.
- Please carry out check the unit regularly for any worn out parts.
- Check the basketball net and re-tie it if the knot is loosened. Failure to do so could be a risk of head / neck entrapment resulting in strangulation. Basketball net can be a strangulation hazard to children under 3 years of age.



- Basketball net may be cleaned with a mild cleaning solution. DO NOT use bleach. DO NOT use harsh or abrasive cleaners. Rinse with water to remove residue. Do not immerse the net.

LIMITED WARRANTY

Our products are covered under warranty for a period of 60 days from the date of purchase, under normal use and service, against defective workmanship and material. If you have recently purchased this product and find it to be defective in anyway, kindly return it to the "Source of Purchase" for a Full Refund or Exchange.

Should the product no longer be covered by your Purchase Receipt, or should you have any questions pertaining to our product, please call our Toll Free Customer Service for assistance.

Keep a copy of the UPC Code with proof of purchase receipt for any future Warranty Service.

Please retain packaging and assembly instructions for future reference.

CUSTOMER SERVICE

USA and Canada
Toll free hotline: 1-888-GNU-9898
Email: service@grow-n-up.com
Other countries: support@grow-n-up.com
www.grow-n-up.com

© 2007 Grow'n Up Ltd. All Rights Reserved.
Tsim Sha Tsui East, Kowloon, Hong Kong.
MADE IN CHINA